

LED **FlexLight**

N1818

- IP67
- UV RESISTANT
- FLAME RESISTANT
- SALTWATER RESISTANT
- SOLVENT RESISTANT
- 50°C / -20°C
- Indoor
- outdoor
- CE
- RoHS
- 3 YEARS WARRANTY
- Anti yellowing

Product Specification

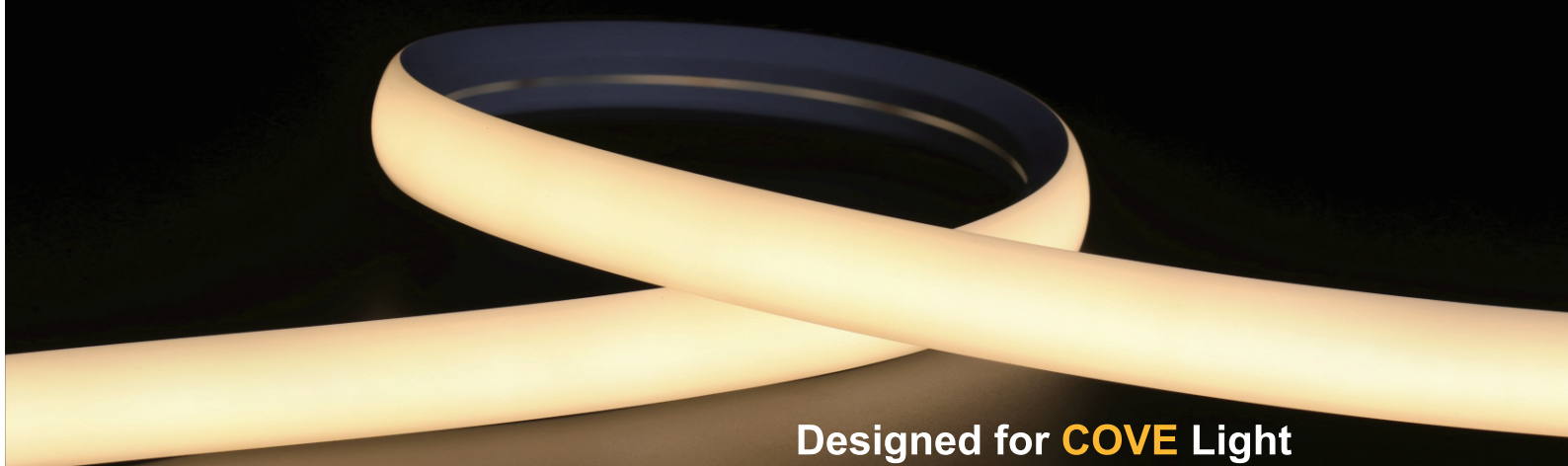

Designed for **COVE** Light

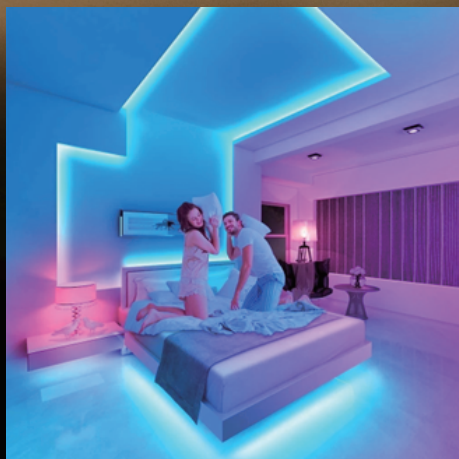



Product Features

- At-yellowing and heat resisting silicone glue, chemical resistance acid and alkaline, available for extremely terrible outdoor environment.
- Uniform and soft luminance, no light spot.
- Super brightness large chip, golden wire welded and copper led holder for quicker heat dissipation, higher stability, longer life span.
- Leadless SMT technique (RoHS certificated), smooth welding joint, firm connection of LED and pcb.

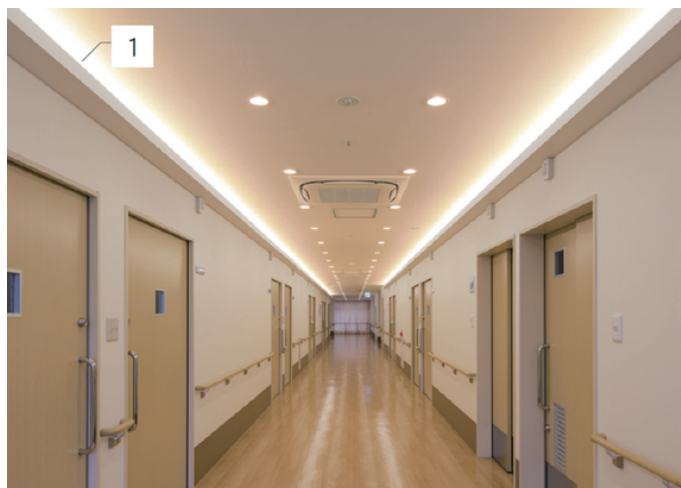

LED strip colloid specifications comparison

Materials Main parameters	Silicone flexible led strip	PVC flexible led strip	Notes
Colloid features in -40 °C	No crack after 30 days	Totally cracked	The low temperature resistant of silicone is superior than PVC or epoxy materials
Colloid features in 120 °C	No obvious change after 72 hours	Colloid changed into yellow and deformed after 2 hours	The high temperature resistant of silicone is superior than PVC or epoxy
Colloid features in 180 °C	No obvious change after 72 hours	Colloid changed into brown and some melted after 20 minutes	Over 150 °C , PVC is easily hydrolyzed, Viscosity becomes weaken and easily separated
Steadily lighted in Seawater for 72 hours	No obvious change	Serious atomization on the surface	The waterproof grade of silicone led strip can reach to IP67, high resistance to acidic alkali and salt properties
Thermal conductivity	Good thermal conductivity	No thermal conductivity	Pvc and epoxy cannot conduct heat, while silicone has good thermal conductivity

Specification

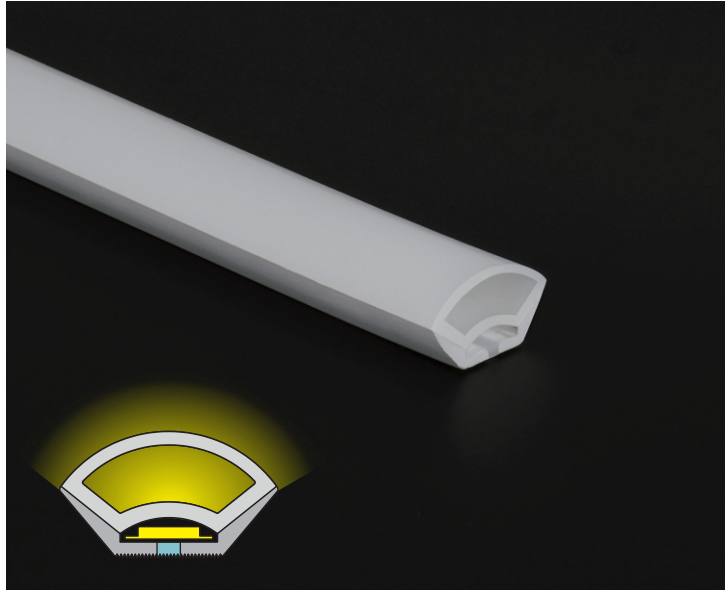

Only can be bent upward or downward (Silicone)

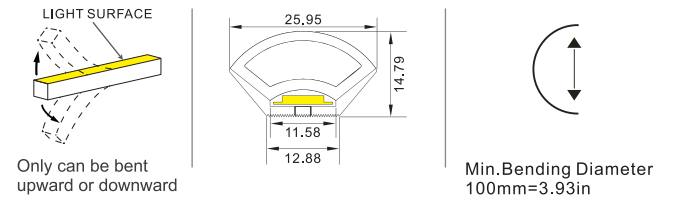

IP67 Protection	Flame Resistant	UV Resistant	Solvents Resistant	Saltwater Resistant
Dirt Resistant	CRI90	3 Years Warranty	Ambient Working 50°C -20°C	Anti yellowing Anti Yellowing

Model Number	N1818	Size(mm)	26*15
PCB Limited (mm)	10	IP Grade	IP67
Working Temperature	-20 to 50°C	N.W.(G/M)	20

Dimensions of Light

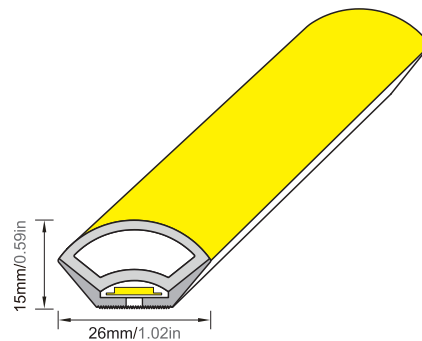
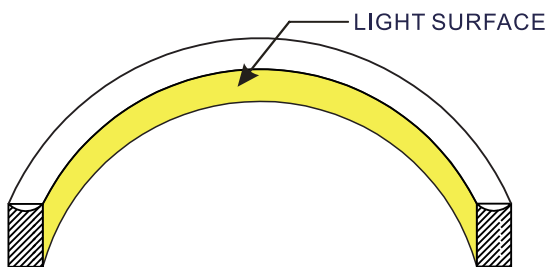

Endcaps

1, Straight cable output:

Connects light to power supply with pre-installed end feed cable, IP67.
Cable length available in 0.2m, 1m, 2m etc.

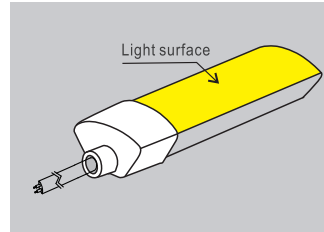
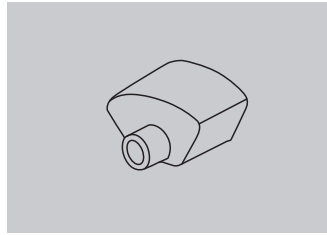
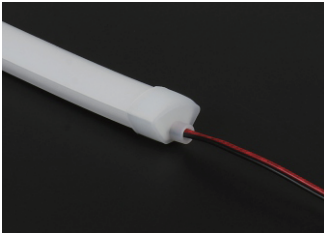

2, End caps without hole:

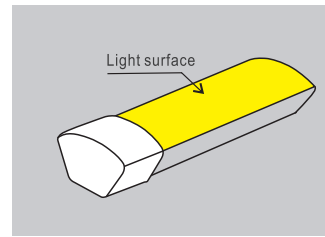
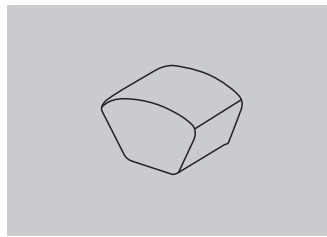
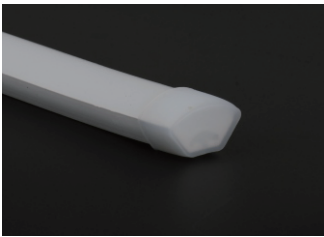

Cut mark

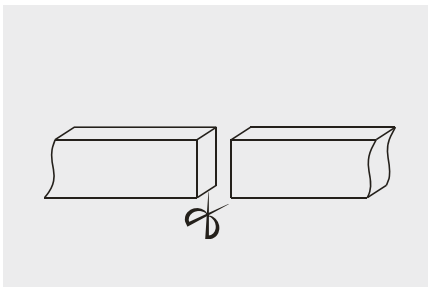

Make precise vertical cuts at the exact cut position of the light strip.

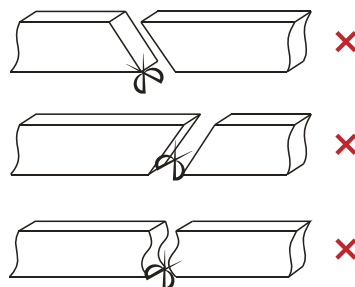

Please do not arbitrarily cut or cut into a bevel and arc section.

Installation accessories

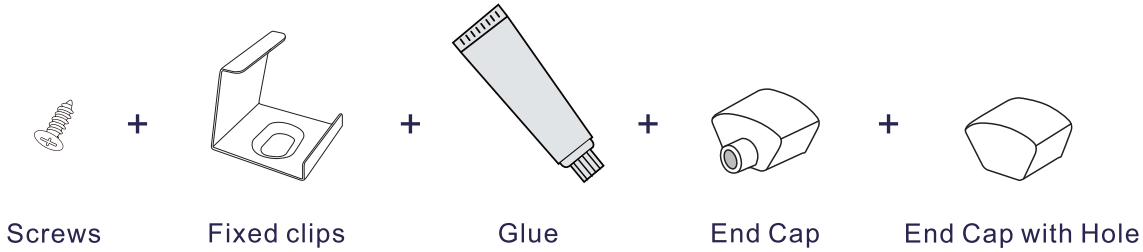

Installation Instructions

Installation DC

> Support 12/24 VDC Strip Light

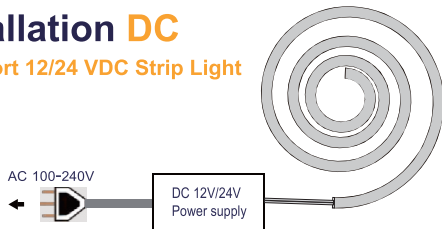

Installation AC

> 220VAC Strip Light

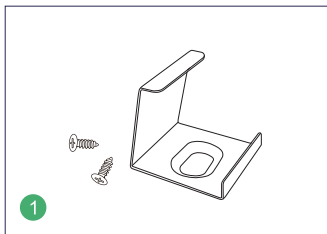
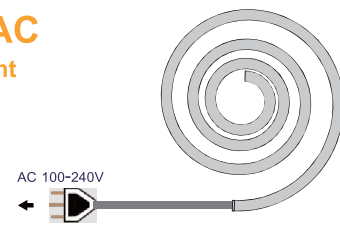

1 Prepare the screws and fixed clips

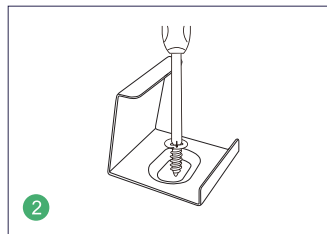

2 Adjust the fixed clips to the appropriate place, use a screwdriver to fix the screw.

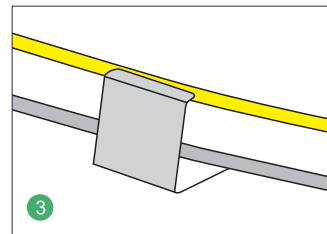

3 Put the light emitting surface upwards, then insert the LED strip into the fixed clips.

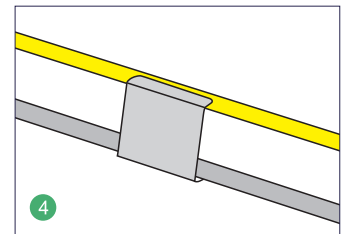

4 Fix led strip completely into the fixed clip, LED strip surface must be parallel to the top edge of fixed clip.

Packaging



50m/Roll



Each roll pack with expandable polyethylene and compression film to fix.



1 Roll/box



Inner size
355x355x305mm

Installation of clip

1. Use screws to fix the clips or carriers on the mounting position
 ⚠️ Clip. 3clips can be used for 1m

Installation of carrier

1. When installing the LED strip, install it from both ends at the same time, installation from one direction is prohibited.

⚠️ If the length of LED strip is over 2m, it is recommended to install by two persons.

2. Use tool to disassemble carefully, and do not pull the LED strip directly.

⚠️ If the length of LED strip is over 2m, it is recommended to disassemble by two persons.

Cautions

- Please notice that the strips are not bendable to all directions. As the appropriate specific shape and degree, please follow the following instruction.
- LED strips are low voltage products, you must use the power supply (transformer). Please don't connect the led strip directly to the AC 110V or AC 220V. Otherwise, it will burn out the LED strips and lead to safety (security) accidents.
- Please read the specifications thoroughly before installation by professional staff to make sure the safe use.

Wrong bending way

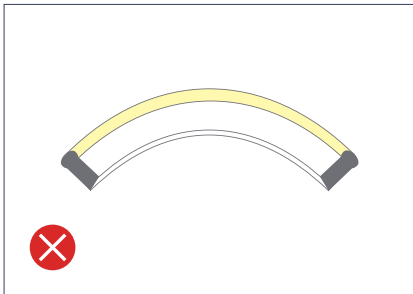

Face to the side surface (as the picture shows). Do not bend downward to damage the strip.

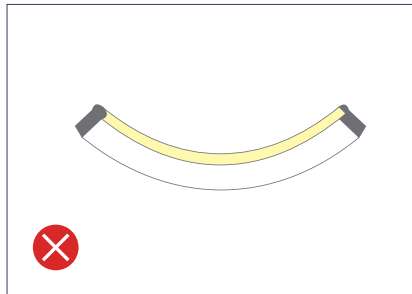

Face to the side surface(as the picture shows). Do not bend upward to damage the strip.

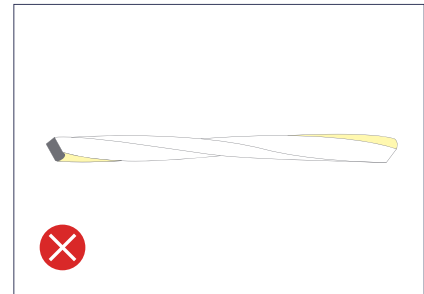

As the picture shows, please do not twist the strip, or it will be damaged.

Correct bending way

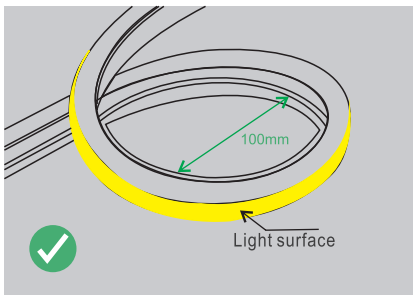

Light surface upwards, the strip is bendable to right or left naturally, the minimum bending diameter is 100mm.

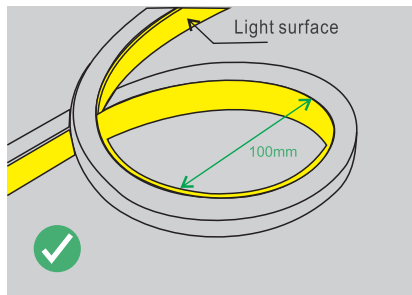

Light surface upwards, the strip is bendable to right or left naturally, the minimum bending diameter is 100mm.