

1. Product Name: LED Stadium Light

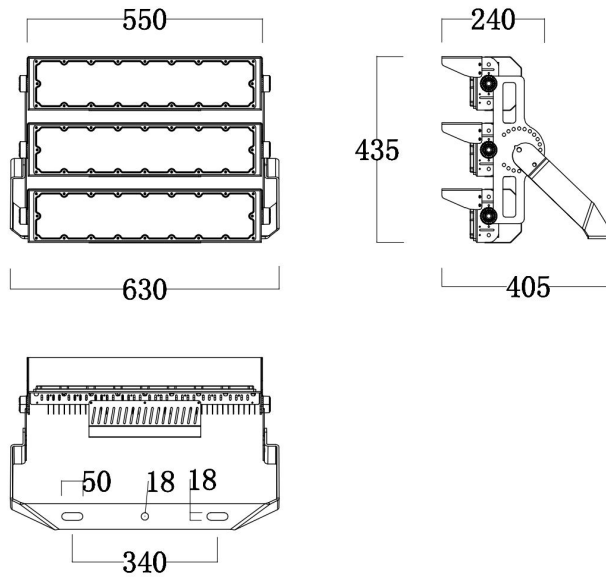

PRODUCT SPECIFICATIONS			
Model No.:	SL-FTS08-W750-X, X can be S and M, S=SOSEN driver, M=Mean Well driver		
Power:	750W		
Input:	AC100-277V, 50/60Hz; AC347V/480V is for option		
PF:	> 0.97		
IP Grade:	IP66		
THD:	10% (at 230v, 50Hz)		
Surge protection:	L/N-PE: 10KV, L-N: 6KV; 20KV version is for option.		
TECHNICAL CHARACTERISTICS			
Color:	Warm White	Natural White	Cool White
Color Temperature:	2700-3200K	4000-4500K/5000-5500K	5700-6500K
CRI:	>70Ra	>70Ra	>70Ra
Light Efficiency:	150-160lm/w		
View angle:	20°, 40°, 60°, 49°x21°(asymmetrical)		
CONFIGURATIONS			
LED chip:	5050 SMD LED(Lumileds)		
Heat sinks:	Aluminum		
Body color:	Black		
OTHERS			
Operating Temperature:	-35°C - 50°C		
Operating Humidity:	10% - 90% RH		
Storage Temperature:	-35°C to 60°C		
Net W./Gross W.:	17.80KGS / 18.90KGS(one piece)		
Packing size:	67x58x30CM, One piece in one carton		
Warranty:	5 years		
Certificates:	CE, RoHS, SAA, ETL		

2. Product size:



3. Applications:

Widely used in shopping mall, billboard, exhibition hall, parking lot, tennis court, gymnasium, park, garden, building facade, any indoor or outdoor areas.



Outdoor tennis court

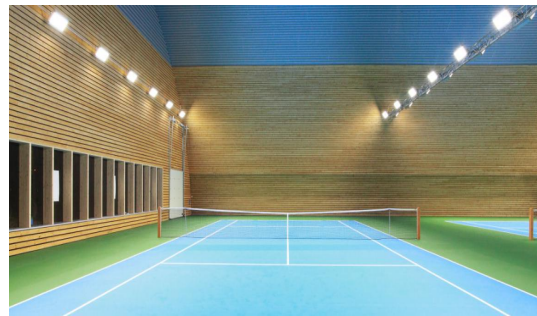

Indoor tennis court



Outdoor car parking lot



Public area

4. Wire connection:

Brown/Black: Live Wire(L)

L  Brown

Blue/White: Neutral Wire(N)

N  Blue

Yellow/Green: Ground Wire(G)

  Yellow

L  Black

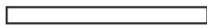
N  White

  Green

(for North America only)



The Ground Wire must be connected correctly!

Warning:

- A. Before installation or wiring the lamps, please make sure the power is switched off;
- B. Before cleaning or repairing the lamp, please make sure the power is switched off;
- C. The lamp body will be very hot while working, do not touch it with your hand.