

MODEL: SL-HACCP-120W

Application

Designed for HACCP and NFS Light solution
For Food and beverage processing industrial

Specification

Electrical Data

Power : 120W ± 5%
Input : 100-277VAC 50-60Hz
Power Factor : >0.95
THD : <15%
SPD : 4 KV

Photometric Data

Luminous Flux : 16,800 lm
Efficiency : 140lm/W
CCT : 3000K / 4000K / 6000K
CRI : >80
LED CHIP : Lumiled
Beam Angle : 60 / 90 / 120
LED Certificate : HACCP / NFS Approved

Mechanical Data

Weight : 5.9 KGS
IP rate : IP66 / IK08
Body Material : Aluminum Diecast
Lens Material : Polycarbonate (PC)

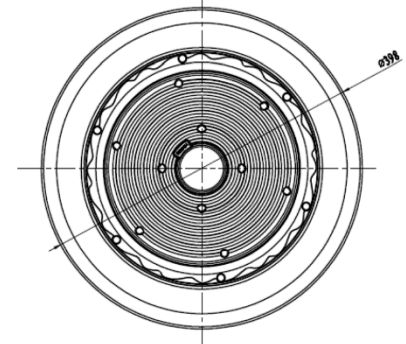
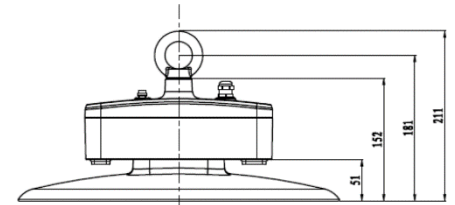

Ordering Data

Model	Watt	CCT	Beam
SL-HACCP-120W	120W	3000K	60D
		4000K	90D
		6000K	120D

Accessories Optional



Microwave Sensor



Reflector



LM79

LM80